

≡COFLOW

# USER MANUAL

V1.0

EcoFlow PowerStream  
Microinverter



# Disclaimer

Read this user manual carefully before using the product to ensure that you completely understand the product and can correctly use it. After reading this user manual, keep it properly for future reference. Improper use of this product may cause serious injury to yourself or others, or cause product damage and property loss. Once you use this product, it is deemed that you understand, approve and accept all the terms and content in this document. EcoFlow is not liable for any loss caused by the user's failure to use this product in compliance with this user manual.

In compliance with laws and regulations, EcoFlow reserves the right to final interpretation of this document and all documents related to this product. This document is subject to changes (updates, revisions, or termination) without prior notice. Please visit EcoFlow's official website to obtain the latest product information.



Hereby, EcoFlow Inc. declares that EcoFlow PowerStream Microinverter is in compliance with Directive 2014/53/EU. The full text of the EU declaration of conformity is available at the following internet addresses:

<http://www.ecoflow.com/eu/eu-compliance>

<http://www.ecoflow.com/de/eu-compliance>

<http://www.ecoflow.com/fr/eu-compliance>



Hereby, EcoFlow Inc. declares that EcoFlow PowerStream Microinverter is in compliance with Radio Equipment Regulations 2017. The full text of the UKCA declaration of conformity is available at the following internet address:  
<http://www.ecoflow.com/uk/eu-compliance>



The crossed-out wheeled bin indicates that the electrical and electronic (EE) product should not be discarded as unsorted waste but must be sent to separate collection facilities for recovery and recycling.



The Bluetooth® word mark and logos are registered trademarks owned by Bluetooth SIG, Inc. and any use of such marks by EcoFlow Inc. is under license. Other trademarks and trade names are those of their respective owners.

---

# Contents

---

<b>Safety Instruction</b>	1
General safety	1
Environment requirements	1
<b>Explanation of Symbols</b>	2
Symbols on the documentation	2
Symbols on the device	2
<b>What's in the Box</b>	3
<b>Overview</b>	4
System overview	4
Product overview	5
LED indication	6
<b>Assembly</b>	7
Pre-assembly	7
Assembly procedure	8
Connecting several solar panels in series or in parallel	13
Mounting the microinverter	17
Grounding considerations	19
<b>EcoFlow App</b>	20
Page of your PowerStream balcony solar system	20
Page of your microinverter	22
<b>Unplug the Cables</b>	23
<b>Troubleshooting</b>	24
<b>Specifications</b>	25

# Safety Instruction

## General safety







1. Please carefully read the documents before installing, operating or maintaining the equipment.  
The documents are subject to change due to product updates or other reasons.
2. Do not put heavy objects on the equipment.
3. Ensure that all cables and connectors are intact and dry before connecting to prevent electric shocks.
4. Use insulation tools or wear personal protective equipment when you install or operate the equipment.
5. Do not install or operate the equipment in extreme weather events such as lightning, snow, heavy rain, strong wind and so on.
6. Do not damage, smear or rip off any warning labels on the equipment.
7. Do not hit, pull, drag, squeeze or step on the equipment, or throw it into the fire, as there is risk of explosion.
8. After installing, please clean the remains of the installation, such as boxes, clipped cable ties, ripped insulation materials, etc.
9. Do not modify or repair the equipment, please contact our customer service or qualified personnel if necessary.
10. Use tools and the equipment correctly to prevent personal injuries and product damage.
11. Understand the components and function of the grid-tied PV power system. Make sure that all electrical connections, and voltage and frequency at the connection point meet the local microinverter grid-tie requirements.
12. Make sure the screws are tightened to the specified torque during installation (M5\*12: 30 Kgf\*cm; ST5\*12: 45 Kgf\*cm; M6\*20: 90 Kgf\*cm).
13. Make sure that the ground wire is tightly connected. The cross-section of ground wire should be  $\geq 4 \text{ mm}^2$ .
14. It is strongly recommended to install an overcurrent circuit breaker between the equipment and the grid.
15. The equipment may get more than 70 °C (158 °F) while in use. Do not touch its enclosure before it cools down. Also, always keep the equipment out of reach of children and pets.
16. The installation location should be convenient for you to pull out the connectors.
17. Before you pull out the AC (or battery) connector from the microinverter, disconnect the cable from the AC socket (or battery's) end.
18. Make sure the portable power station is off during the whole connection process.

## Environment requirements

1. Make sure the equipment is installed, operated or stored in a well ventilated place.
2. Do not install or operate the equipment near flammable, explosive, corrosive, caustic or moist sources.
3. Do not expose the equipment to strong electromagnetic fields to avoid radio interference.

# Explanation of Symbols





## Symbols on the documentation

Symbol	Explanation	Symbol	Explanation
	A hazard with a high level of risk which, if not avoided, will result in death or serious injury.		Indicates additional information on correct use or useful tips.
	A hazard with a low level of risk which, if not avoided, will result in minor injury, or damage to the device.		In a basic set
	Important information that you need to pay attention to.		Optional (not in the box)

## Symbols on the device

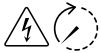

Do not damage, smear or cover any warning labels on the device. All labels must be visible after installation.

Symbol	Explanation	Symbol	Explanation
	Refer to the operation instructions		Caution, risk of electric shock; energy storage timed discharge
	Caution, hot surface		The position for connecting the protection ground cable
	Caution, risk of danger	<b>IP67</b>	Ingress Protection rating

# What's in the Box



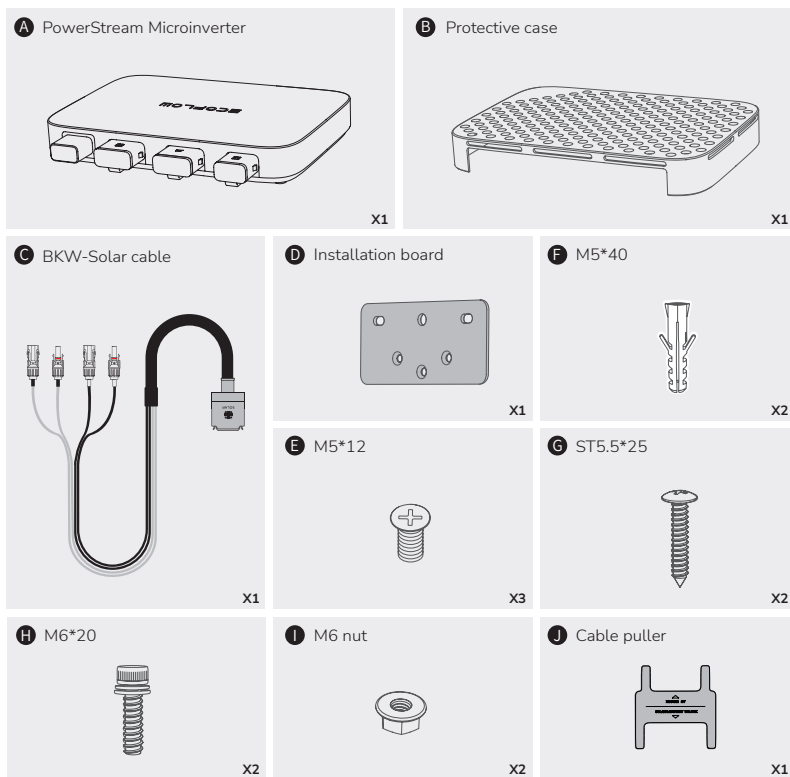

- The images of the product and components may differ from the actual product.
- If there are missing or defective components, please contact EcoFlow customer service.



<p><b>D E F G</b></p>	<p>Used for mounting the microinverter on the wall. See "Mount on the wall" for details.</p>
<p><b>D F H I</b></p>	<p>Used for mounting the microinverter on the bracket. See "Mount on the bracket" for details.</p>
<p><b>J</b></p>	<p>Used for disconnection, located at the bottom of the protective case. See "Unplug the Cables" for details.</p>



No.	Name	Description	In a basic set / Optional (not in the box)
8	BKW-AC cable	Used for connection of the microinverter to the power grid.	
9	EcoFlow Smart Plug	Used for monitoring the power of appliances and for wireless communication with the microinverter to optimize the energy usage.	



You can purchase optional accessories from the official EcoFlow website.

## Product overview

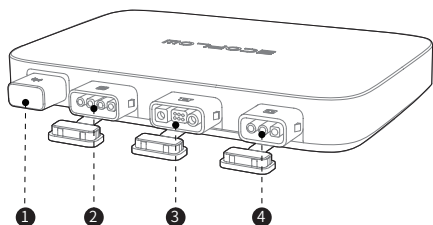

- ① Antenna
- ② PV port
- ③ Battery port / DC port
- ④ AC output port

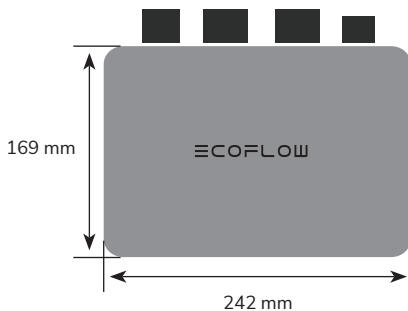



## LED indication

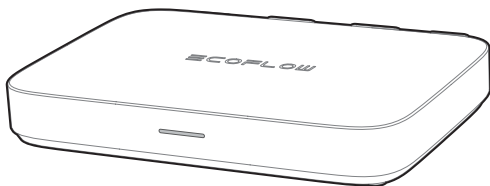

LED indicator	Color	Status	Feeding electricity (power grid)	Feeding electricity (Smart Plug)	Detailed explanation
	Green	Breathing	☑	☑	There is power input and AC output. Electricity is fed to Smart Plug(s) for use by appliances.
		Solid	☑	☒	There is power input and AC output, but no electricity is fed to Smart Plug(s).

	White	Solid	Power on	There is PV input or/and the power station discharges (DC input), without any power output.
		Breathing	Charging	There is PV input and the power station is charged (DC output), without AC out.
	Purple	Blinking	Updating	Updating the firmware.
	Blue	Blinking	Pairing	Pairing with EcoFlow app.
	Yellow	Solid	Warning	See "Troubleshooting" for details.
	Red	Solid	Error	See "Troubleshooting" for details.

# Assembly

## Pre-assembly

### NOTICE

- This user manual only provides the cable connection method and the mounting method for the microinverter. For installing the solar panel, please refer to the instructions for the solar panel and its accessories.
- If you wish to verify the solar system, complete the assembly on a sunny day.

### Select a location for the PowerStream Microinverter

Make sure that the microinverter is within the Wi-Fi coverage.

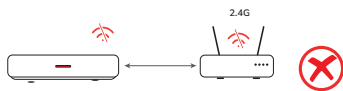
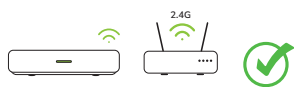

Do not place or install the microinverter in an area where flammable or explosive materials are stored.

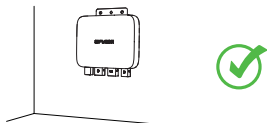

The IP rating of the microinverter is IP 67, hence, it can be installed either indoors or outdoors. However, the EcoFlow portable power station is not waterproof. If your system includes a portable power station, keep both of them indoors.

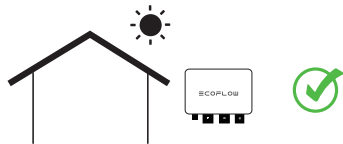
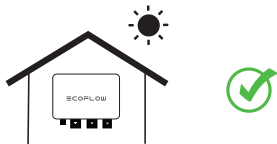

## Measure the distance

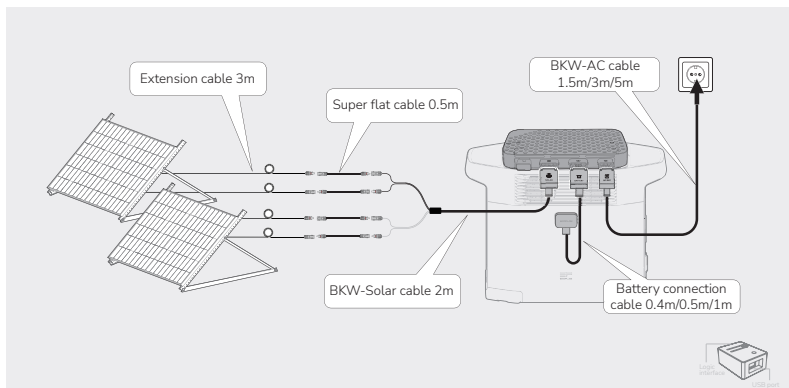

- The lengths of cables vary in different countries or regions. Please refer to the actual products.
- Except for the standard BKW-Solar cable and the BKW-AC cable, other cables need to be purchased from the official website.

## Assembly procedure

### 1. Place the microinverter on the Ecoflow portable power station.



If you need to mount the microinverter, please refer to "Mounting the Microinverter".

## 2. Connect with solar panels.

### NOTICE

A BKW-Solar cable includes two groups of MC4 connectors, which can connect with two groups of solar panels.

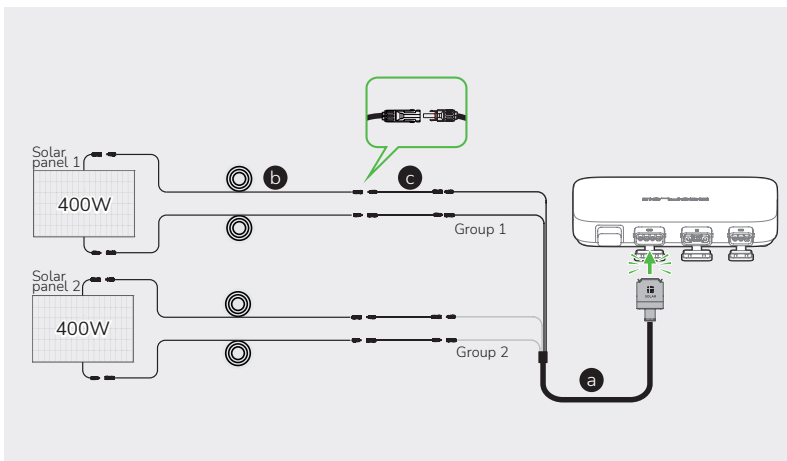
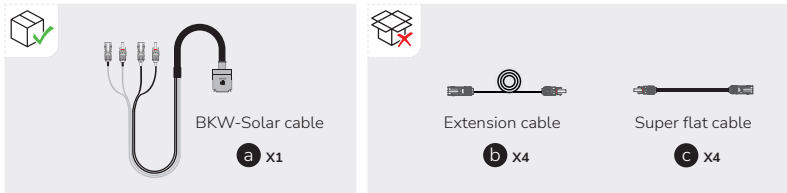

- After the solar panels capture solar radiation, they provide direct current to the microinverter. At this time, the LED indicator will light up white.
- If you connect several solar panels in series or in parallel as a group, refer to "Connecting several solar panels in series or in parallel".
- If you connect the EcoFlow River-series portable power station to the DC port of the microinverter, it is recommended to connect solar panels to the power station, otherwise, the energy will not be stored.

For the connection, refer to the user manual of the power station. Download user manuals at <https://www.ecoflow.com/eu/support/download/>.

### 3. Connect with the EcoFlow portable power station.

There are three types of battery connection cables for different EcoFlow portable power stations, as shown in the figures below.

#### NOTICE

- Make sure the portable power station is off during the whole connection process.
- If you use the EcoFlow BKW-RIVER cable for the EcoFlow River-series portable power station, the power station only discharges power but does not receive a charge.



BKW-DELTA  
EB cable



BKW-DELTA  
PRO cable

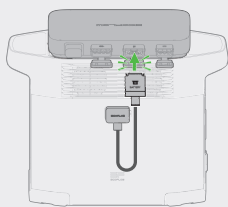

Delta 2 series and Delta Max series

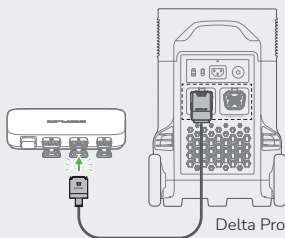

Delta Pro series



BKW-RIVER  
cable

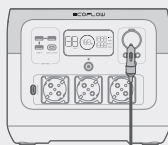

River series, Delta  
mini, and Delta 1300

#### 4. Connect to the power grid.

##### NOTICE

Please confirm that the AC socket is switched on, and the power grid is being powered.

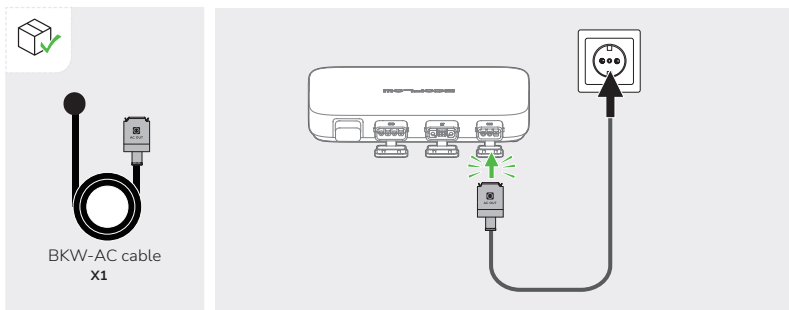

#### 5. Turn on the EcoFlow portable power station.

##### NOTICE

If your PowerStream balcony solar system does not include a portable power station, skip this step.

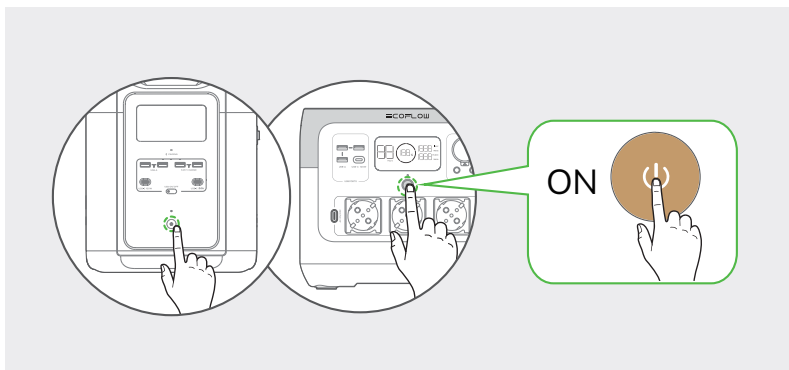

After completing the connection, the LED indicator will light up green when the solar panel captures solar radiation and the microinverter outputs AC.

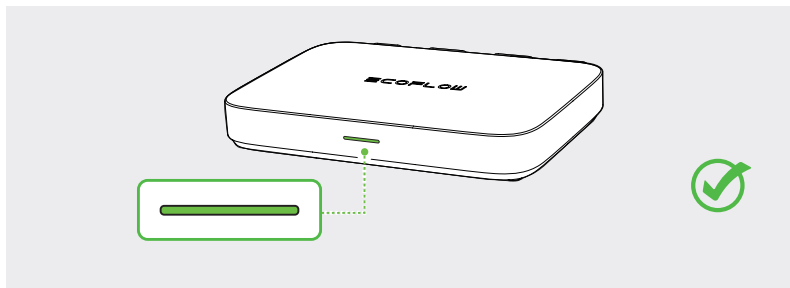

It is highly recommended to install the protective case on the microinverter. The protective case is in the box.

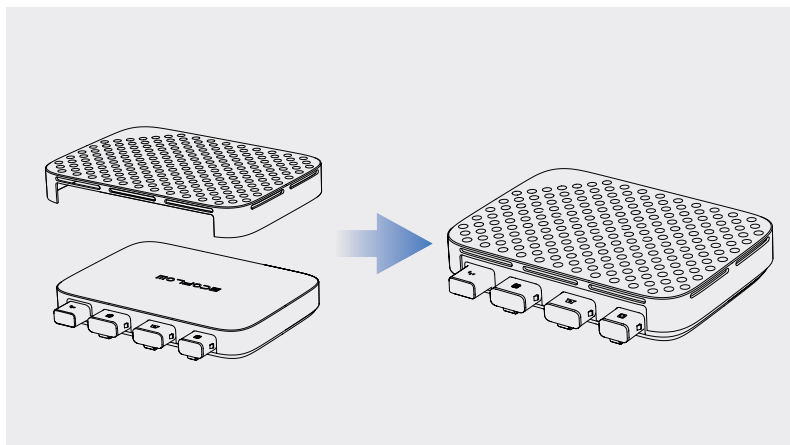

## Connecting several solar panels in series or in parallel

### NOTICE

- If you connect several solar panels in series or in parallel as a group, make sure that the maximum operating voltage (Vm) and maximum operating current (Im) of each group do not exceed the maximum input voltage (55V) and maximum output current (13A) of the microinverter PV input.
- The maximum operating voltage (Vm) and maximum operating current (Im) of solar panels must be consistent respectively.

### Solar panels in series

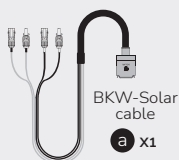

BKW-Solar cable  
a X1



Extension cable  
b X4



Super flat cable  
c X4

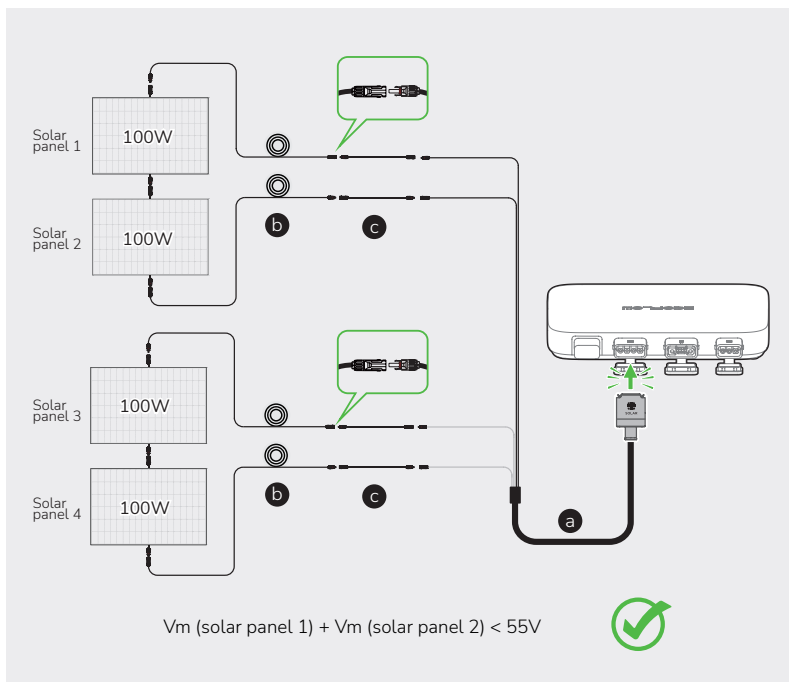



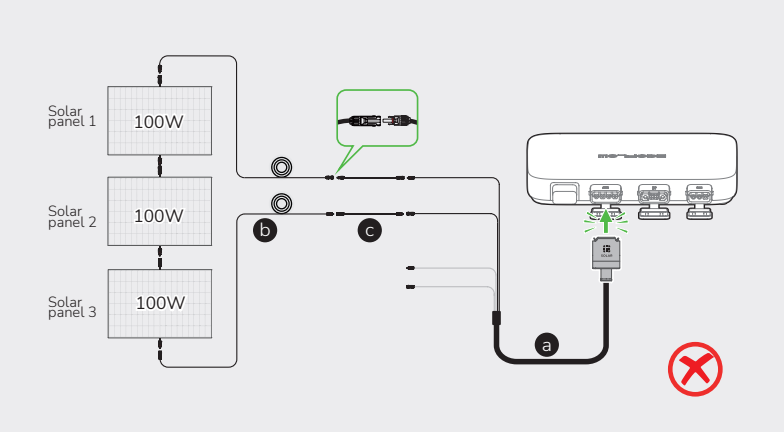

## Solar panels in both series and parallel

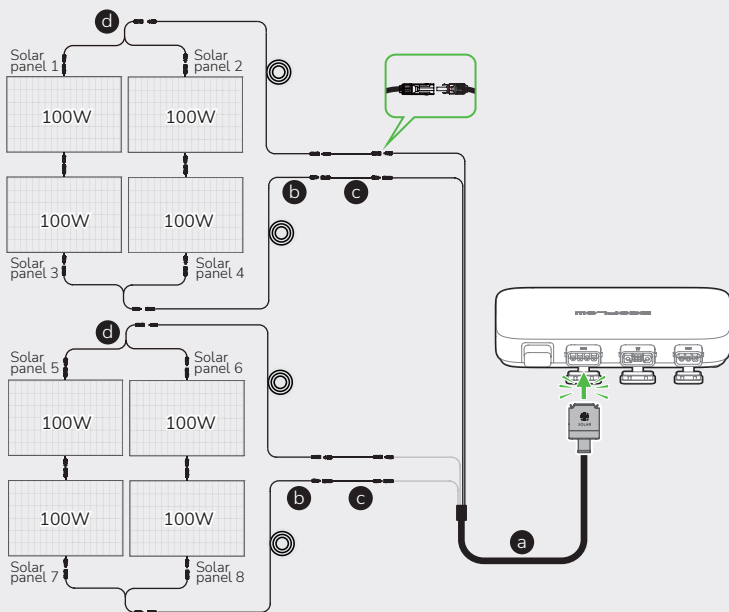
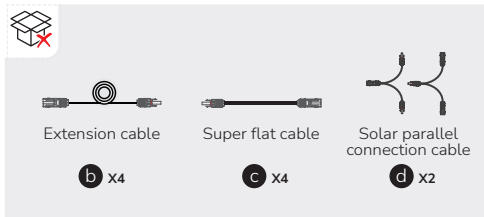
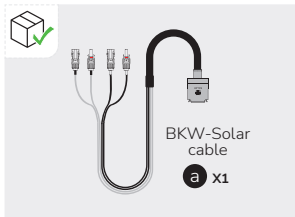

$V_m(\text{solar panel 1}) + V_m(\text{solar panel 2}) < 55V$   
 $I_m(\text{solar panel 1}) + I_m(\text{solar panel 2}) < 13A$



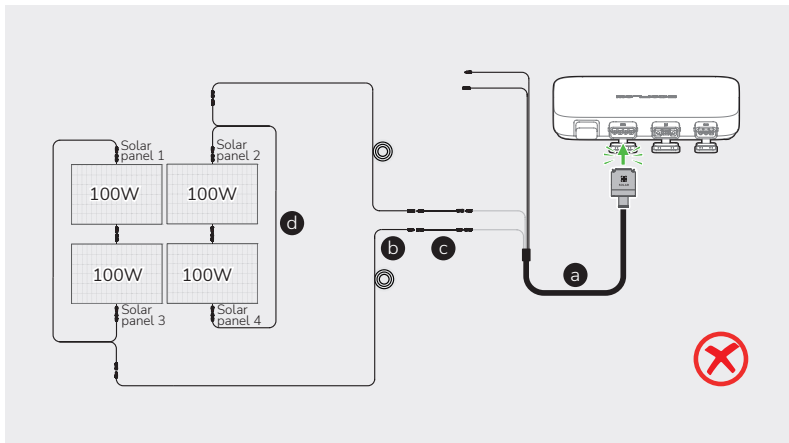

## Mounting the microinverter

If your balcony solar system does not include a power station, you can mount the microinverter.

**⚠ DANGER** Wear protective goggles or gloves when drilling holes.

### Mount on the wall

1. Use the installation board to locate the hole and drill two holes about 41 mm in depth in the wall. Then, insert M5\*40 into the holes.

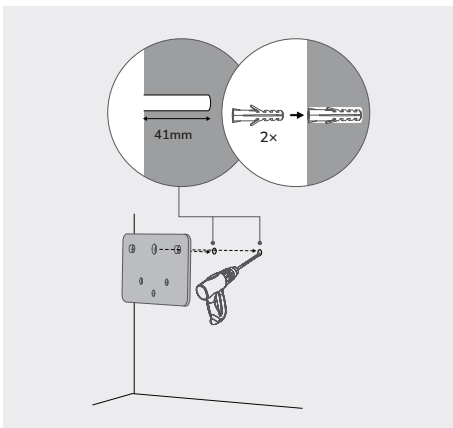
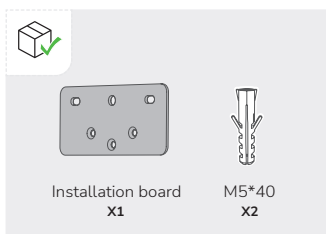

2. Install M5\*12 in the corresponding positions on back of the microinverter.

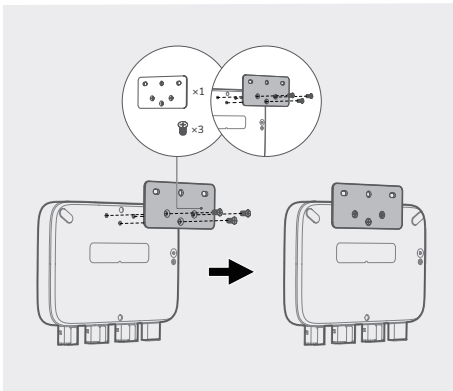
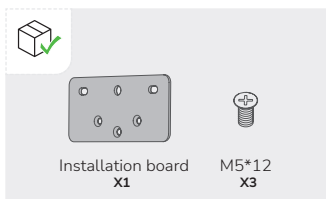
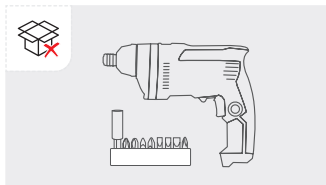

3. Insert ST5.5\*25 into M5\*40 through holes of the board.

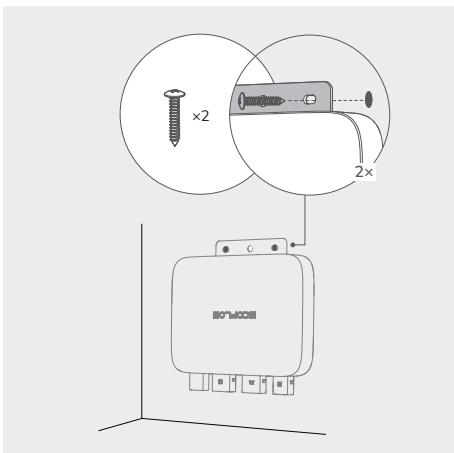
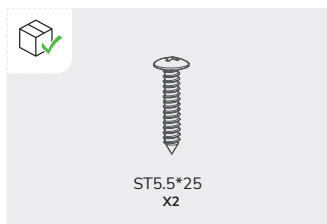
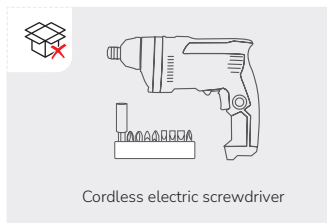

## Mount on the bracket

1. Install M3\*6 in the corresponding positions on back of the microinverter.

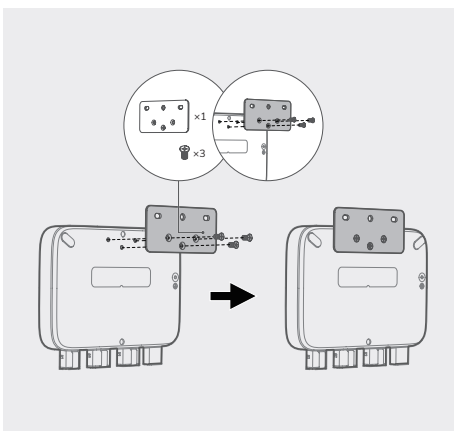
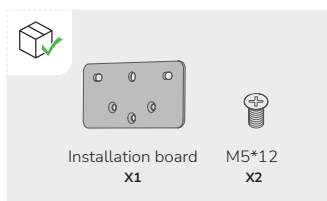
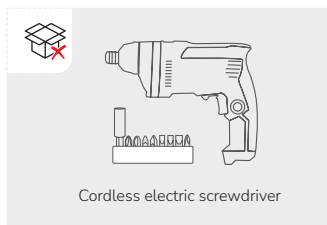

2. Install two M6\*20 in two holes of the installation board, and tighten M6 nuts on them.

**CAUTION** Please install vertically  $\leq 15^\circ$  for stability and safety.

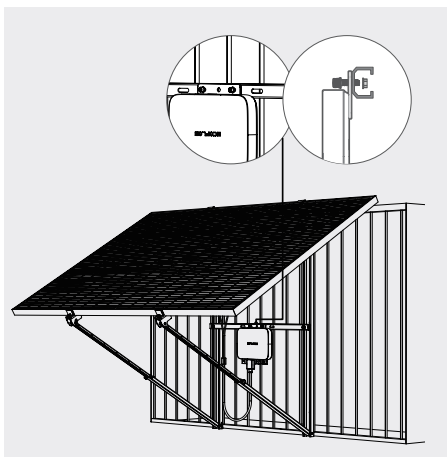
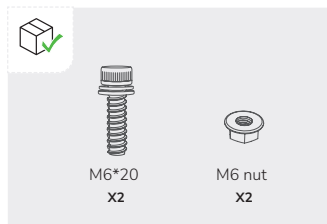
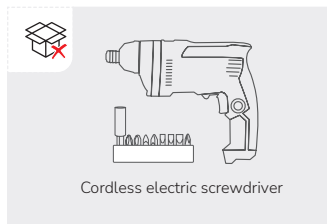

## Grounding considerations

There is an earth wire inside the supplied BKW-AC cable, so grounding can be done directly by using this BKW-AC cable.

If you need to add an additional grounding conductor:

Tools and components (not provided): an M4\*6 screw, a grounding wire (cross-section  $\geq 4 \text{ mm}^2$ ) with a connection tool, safety gloves and a drill.

1. Find the grounding terminal on the bottom of the microinverter.
2. Insert M4\*6 into the grounding terminal through the connection tool of the grounding cable.

# EcoFlow App

## NOTICE

The figures are for reference only, please refer to the actual app interface.

Control, monitor, and customize your EcoFlow PowerStream microinverter from afar with the EcoFlow app.

Download at: <https://download.ecoflow.com/app>

## Privacy policy

By using EcoFlow Products, Applications, and Services, you consent to the EcoFlow Term of Use and Privacy Policy, which you can access via the "About" section of the "User" page on the EcoFlow App or on the official EcoFlow website at

<https://www.ecoflow.com/policy/terms-of-use> and

<https://www.ecoflow.com/policy/privacy-policy>

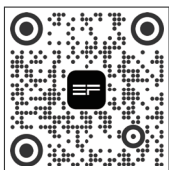

## Page of your PowerStream balcony solar system

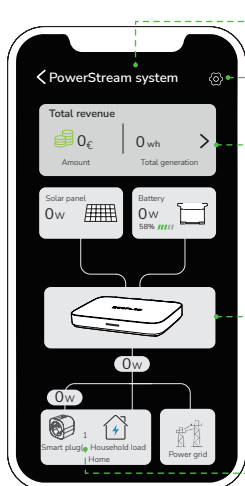

Name of your PowerStream system

Tap to enter the Setting page of your system.

Check cumulative power generation and savings. Tap ">" to view historical data by data, week, month, or year.

Check real-time power generation, storage and supply.

Number of Smart Plugs in the system

## Setting the power supply mode

### NOTICE

This feature can be enabled when the portable power station is connected.

On the page of your Powersystem system, tap  > "System setting" > "Power supply mode". Then, select the mode you need.

- **Prioritize power supply:** Select this option if you want to prioritize meeting the power consumption of electrical appliances. In this mode, when the power supply exceeds the demand for electrical appliances, the portable power station will be charged. When the demand for electrical appliances is less than the power supply, the portable power station will discharge.
- **Prioritize power storage:** Select this option if you want to prioritize charging the portable power station until it reaches its charging limit. In this mode, the portable power station will not discharge.

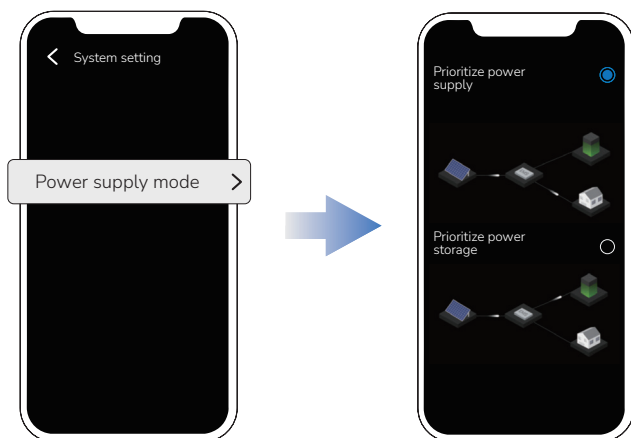

## Setting the output power of the system

On the page of your PowerStream system, tap  > "System setting" > "Output power of the system". Then, specify the continuous output power of the microinverter to set the overall output power of the system.

The output power of the system = continuous output power of the microinverter + power of the smart plug.



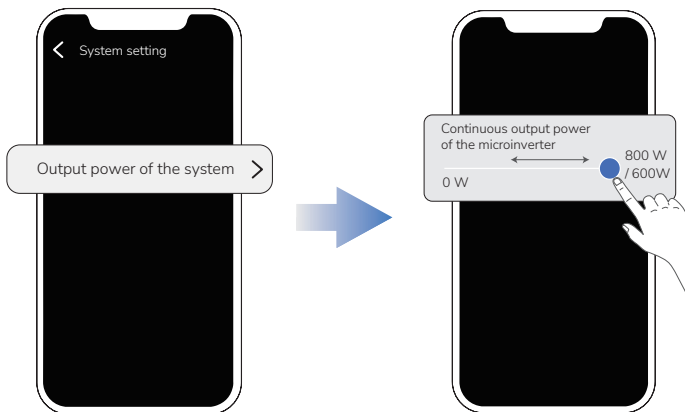

## Firmware update

On the page of your Powersystem system, tap  > "System setting" > "Firmware" to check the firmware version or update the firmware.



You can also update the firmware on the "Setting" page of your microinverter.

## Page of your microinverter

In the list of your devices, tap the microinverter to go to the page of your microinverter.

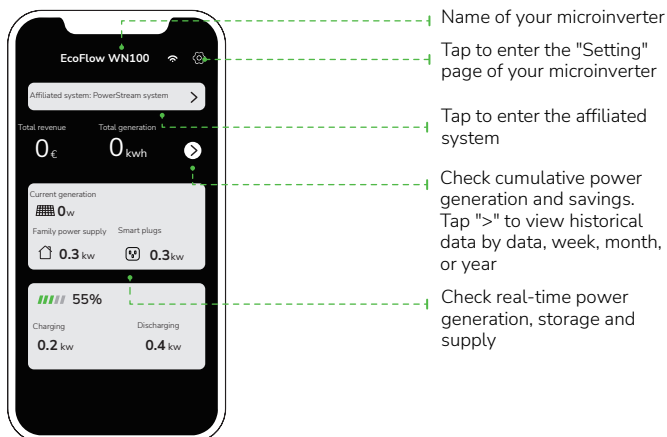

# Unplug the Cables



**DANGER**

- Do not remove the connector with your hand only. Please use the cable puller supplied with the product to assist in pulling out the connector.
- If you have installed the protective case, please remove the protective case from the microinverter before you pull out the connector.

## Where is the cable puller?

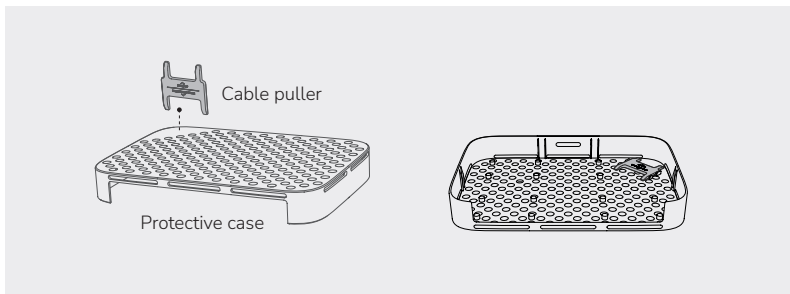

## How to use the cable puller?



**CAUTION** Before you remove the battery connection cable, turn off the power station.

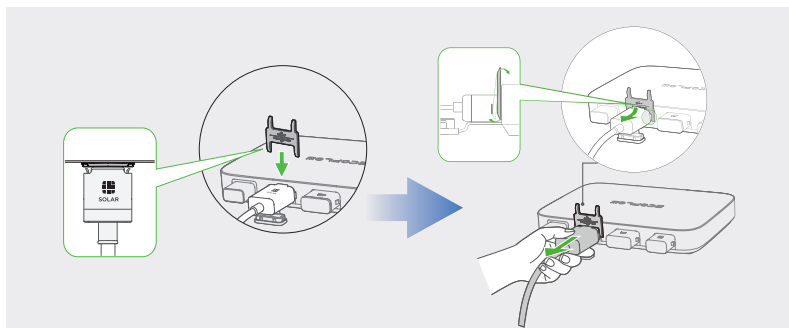

## Remove connectors in the following order:

### NOTICE

Before you pull out the AC (or battery) connector from the microinverter, disconnect the cable from the AC socket (or battery's) end.

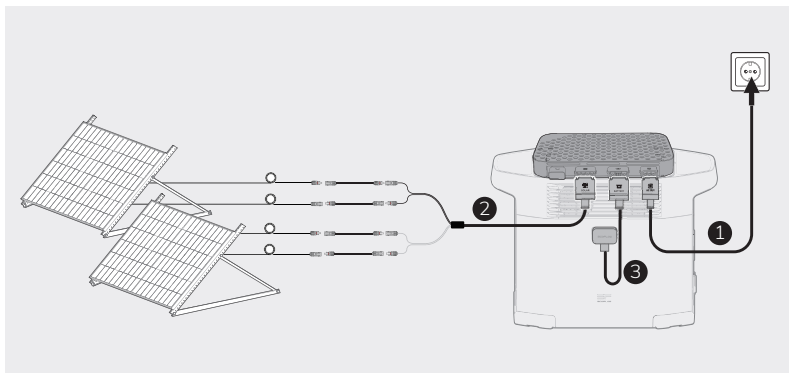

## Troubleshooting

If the LED indicator turns yellow or red, warning or errors occur. Please follow the instructions in the app or the table below to deal with the problem. If it is not eliminated, please contact the customer service.



### DANGER

Do not attempt to repair the microinverter.

# Specifications

General info	
Model	EFWN511/EFWN511B
Dimension	242×169×33 (mm)
Weight	Approximately 3 kg
PV port	
Operating voltage	11 - 55 Vd.c.
Maximum input voltage	55 Vd.c.
Maximum input current	13 A
Initial input voltage	15 Vd.c.
Anti-reverse connection protection	Supported
Overvoltage	II
Max. PV short circuit current (Isc PV)	14 A
Max. inverter backfeed current to the array	0 A
BAT / DC port	
Discharging mode	
Maximum input current	13 A
Input voltage	11 - 15 Vd.c. , 40 - 59 Vd.c.
Maximum input voltage	59 Vd.c.
Charging mode	
Charging voltage	30 - 58 Vd.c.
Maximum charging current	13 A
Rated charging voltage	48 Vd.c.
Overvoltage	II
Battery input short circuit current rating	20 A
AC port	
Output voltage	220/230/240 Va.c.

Output frequency	50 Hz
Output power factor	±0.8 ~ 1
Maximum output current	3.6 A
Maximum output fault current	18.4 A
Maximum output overcurrent protection	4 A
THDI	<=3%@100% load
Overvoltage	III
<b>Others</b>	
Placed	Indoors or outdoors
Pollution degree	PD3
Ingress Protection rating	IP67
Operating temperature	-40 °C to 50 °C
Humidity	0 % to 100 %
Altitude	≤2000 m
Wet location	Yes
Type of inverter	Isolated
Protective class	1
Wi-Fi (2.4G)	Frequency range: 20M: 2412 - 2472 MHz / 40M: 2422- 2462 MHz Maximum output power: ≤ 20 dBm
Bluetooth®	Frequency range: 2402-2480MHz Maximum output power: ≤ 20 dBm

For updated parameters, please go to our website to download the latest user manual.



**PAP**  
Raccolta carta